

- 1 90° connector
- 2 Gasket
- 3 Connector
- 4 Check valve
- 5 c-ring
- 6 o-ring
- 7 Foot nut
- 8 Connector
- 9 Fastening plate
- 10 Body
- 11 Fixing screws
- 12 Diverter
- 13 Lock nut
- 14 Limiter
- 15 Hex screws
- 16 Limiter screws
- 17 Diverter cover
- 18 Splined extender
- 19 Screw
- 20 Decorative cover ring
- 21 o-ring
- 22 Washer
- 23 Handwheel bar
- 24 Handwheel
- 25 Inner hex screw
- 26 Decoration rubber
- 27 Handwheel bar
- 28 Button spring
- 29 Thermostatic handle
- 30 Handwheel plug
- 31 Screw
- 32 Temperature limiter
- 33 Spline bushing
- 34 Thermostat cover
- 35 Thermostat lock nut
- 36 Thermostatic cartridge
- 37 Fixing screws
- 38 Gasket
- 39 Decorative cover ring
- 40 Hand shower holder pipe
- 41 Hand shower holder pipe
- 42 Screw
- 43 Hand shower holder pipe
- 44 Hose
- 45 Tattle pipe cover
- 46 o-ring

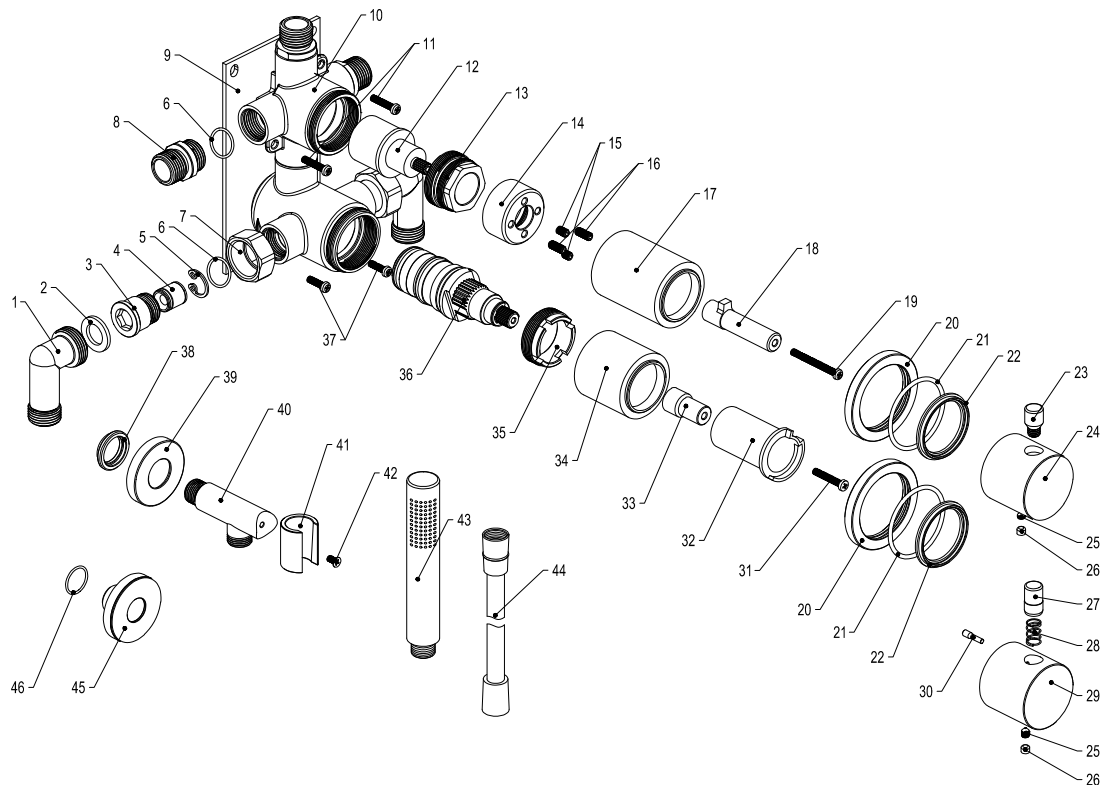

# Harmonized 2x Scrap

Art no: 21022 RSK: 8351521

**SCANDTAP**  
BATHROOM CONCEPTS

Scandtap AB, Olofsdalsvägen 21, 302 41 Halmstad, Sweden  
info@scandtap.com, www.scandtap.com



Typgodkännande  
Nr: 1786-1787

